

PART NUMBER		PART NUMBER		DESCRIPTION	STD.	OPT
TRADITIONAL		DINETTE				
1	K 41 01 01 285	K 41 03 01 285		STARBOARD V-BERTH	1	1
2	K 41 01 03 285	K 41 03 03 285		PORT V-BERTH	1	1
3	K 41 01 08 285	K 41 03 08 285		V-BERTH FILLER	1	1
4	K 41 01 11 285	K 41 03 11 285		FORWARD SETTEE	1	1
5	K 41 01 13 285	K 41 03 13 285		AFT SETTEE	1	1
6	K 41 01 18 285	K 41 03 18 285		FORWARD PORT SIDE	1	1
7	K 41 01 19 285	K 41 03 19 285		MIDDLE, PORT SIDE	1	1
8	K 41 01 20 285	K 41 03 20 285		AFT, PORT SIDE	1	1
9		K 41 03 16 285		FORWARD DINETTE		1
10	K 41 01 21 285	K 41 03 21 285		FORWARD ENGINE COMPARTMENT	1	1
	K 41 01 22 285	K 41 03 22 285		FORWARD ENGINE COMPARTMENT HATCH LID FOR UNIVERSAL DIESEL #5411	1	1
11	K 41 01 24 285	K 41 03 24 285		AFT ENGINE COMPARTMENT	1	1
	K 41 01 24F	K 41 03 24F		FASTENER KIT: (2) #10x1 1/4" SLOT. OHSMS, S.S.	1	1
12	K 41 01 14 285	K 41 03 14 285		BILGE COVER	1	1
	K 41 01 14F	K 41 03 14F		FASTENER KIT: (2) #10x1 1/4" SLOT. OHSMS, S.S.	1	1
				(2) #10 FINISH WASHER, S.S.		
13	K 41 01 16 285	K 41 03 16 285		STUFFING BOX	1	1
14	K 41 01 25 285	K 41 03 25 285		QUARTERBERTH	1	1
	K 41 01 00 285			TRADITIONAL INTERIOR SET	1	
		K 41 03 00 285		DINETTE INTERIOR SET		1
	K 42 09 00 115			TRADITIONAL INTERIOR CARPETING		1
		K 42 10 00 115		DINETTE INTERIOR CARPETING		1

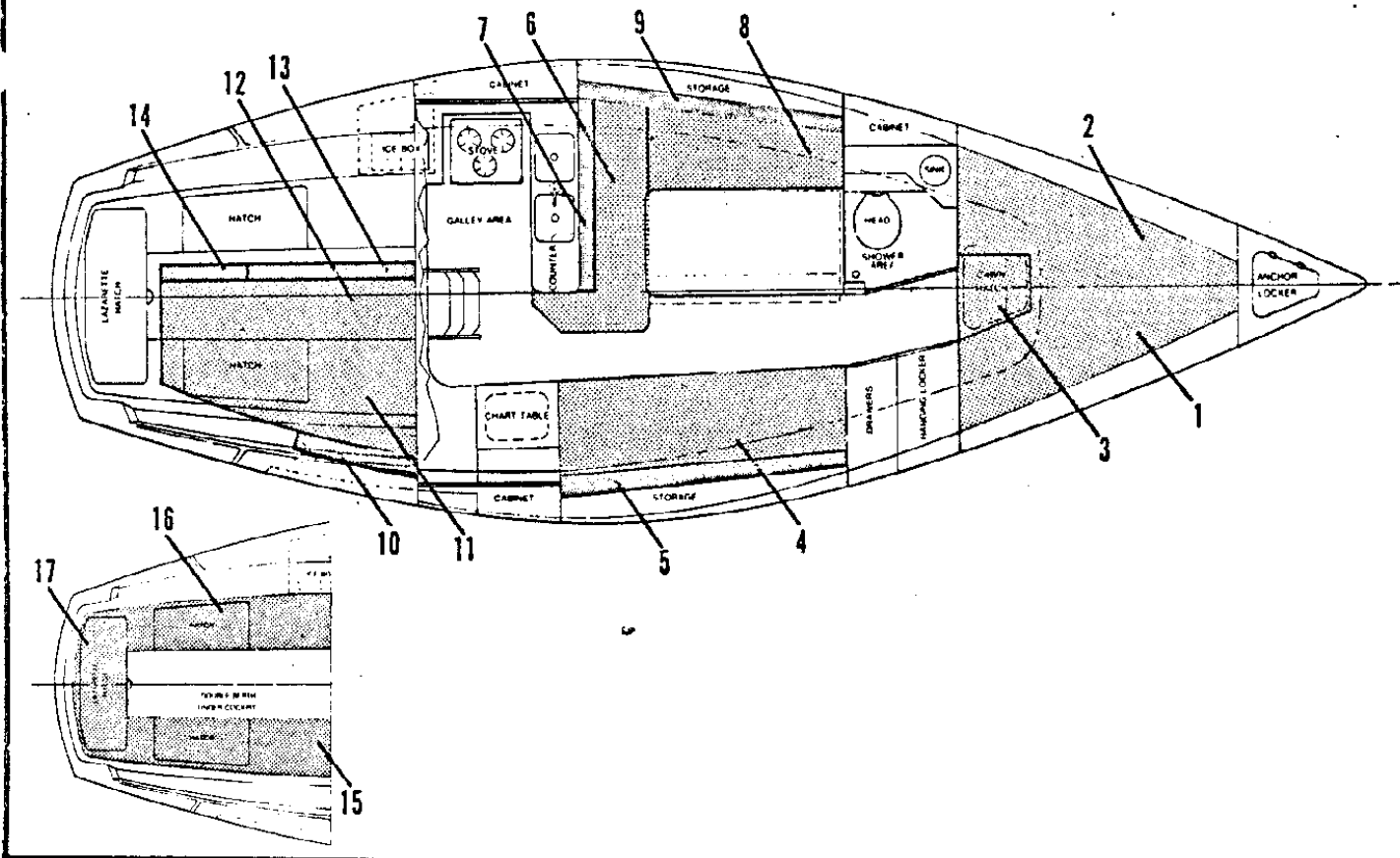

REF.	PART NUMBER	PART NUMBER	DESCRIPTION	STD.	OPT.
	4" FABRIC		PILLOW TYPE		
1	K 40 22 01 390	K 40 38 01 390	STARBOARD V-BERTH	1	1
2	K 40 22 03 390	K 40 38 03 390	PORT V-BERTH	1	1
3	K 40 22 05 390	K 40 38 05 390	V-BERTH FILLER	1	1
4	K 40 22 07 390	K 40 38 07 390	STARBOARD SETTEE BOTTOM	1	1
5	K 40 22 09 390	K 40 38 09 390	STARBOARD SETTEE BACK	1	1
6	K 40 22 12 390	K 40 38 12 390	PORT AFT BOTTOM	1	1
7	K 40 22 14 390	K 40 38 14 390	PORT AFT BACK	1	1
8	K 40 22 16 390	K 40 38 16 390	PORT SIDE BOTTOM	1	1
9	K 40 22 18 390	K 40 38 18 390	PORT SIDE BACK	1	1
10	K 40 22 25 390	K 40 38 25 390	QUARTERBERTH STARBOARD BACK	1	1
11	K 40 22 27 390	K 40 38 27 390	QUARTERBERTH STARBOARD BOTTOM	1	1
12	K 40 22 29 390	K 40 38 29 390	QUARTERBERTH PORT BOTTOM	1	1
13	K 40 22 31 390	K 40 38 31 390	QUARTERBERTH PORT FORWARD BACK	1	1
14	K 40 22 33 390	K 40 38 33 390	QUARTERBERTH PORT AFT BACK	1	1
	K 40 22 00 390		4" FABRIC CUSHIONS SET	1	
		K 40 38 00 390	PILLOW TYPE CUSHIONS, SET		1
	AFT TRAVELER	MIDSHIP TRAVELER	COCKPIT CUSHIONS		
15	K 40 06 01 390	K 40 08 01 390	STARBOARD COCKPIT		1
16	K 40 06 03 390	K 40 08 03 390	PORT COCKPIT		1
17	K 40 06 05 390	K 40 08 05 390	LAZARETTE		1
			AFT TRAVELER SET		1
		K 40 08 00 390	MIDSHIP TRAVELER SET		1
SPECIFY COLOR, PATTERN AND MATERIAL WHEN ORDERING CUSHIONS FROM AVAILABLE SELECTION					

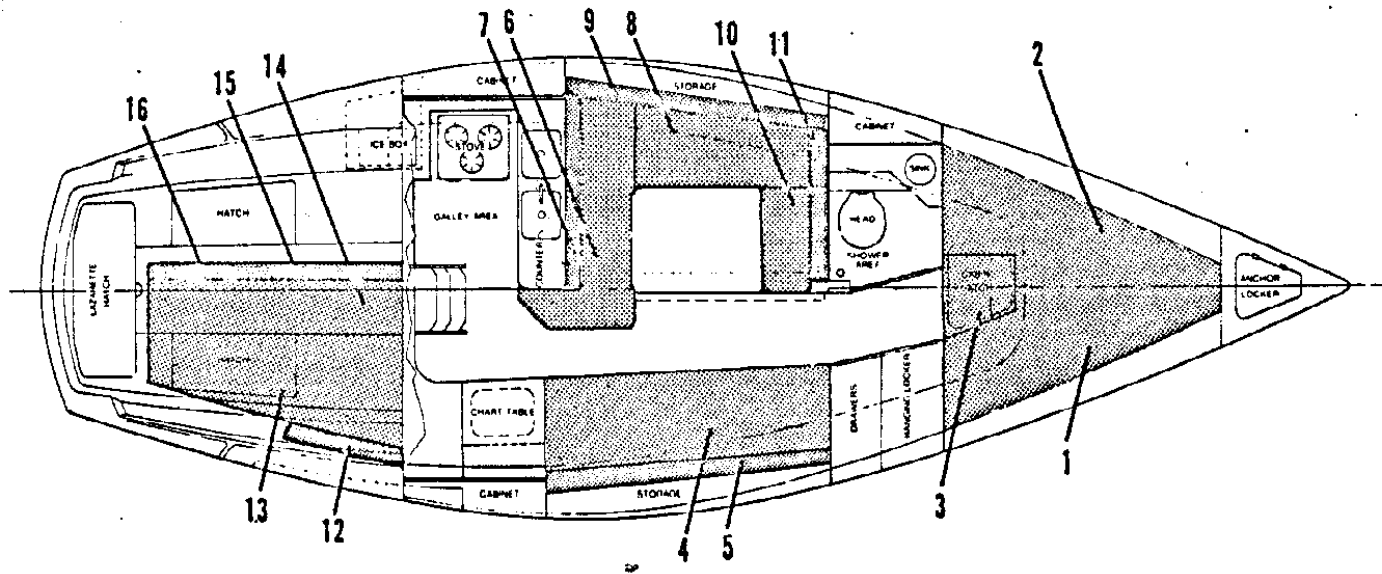

F. PART NUMBER PART NUMBER DESCRIPTION STD./OPT

4" FABRIC		PILLOW TYPE			
1	K 40 26 01 390	K 40 40 01 390	STARBOARD V-BERTH	1	1
2	K 40 26 03 390	K 40 40 03 390	PORT V-BERTH	1	1
3	K 40 26 05 390	K 40 40 05 390	V-BERTH FILLER	1	1
4	K 40 26 07 390	K 40 40 07 390	STARBOARD SETTEE BOTTOM	1	1
5	K 40 26 09 390	K 40 40 09 390	STARBOARD SETTEE BACK	1	1
6	K 40 26 12 390	K 40 40 12 390	PORT AFT BOTTOM	1	1
7	K 40 26 14 390	K 40 40 14 390	PORT AFT BACK	1	1
8	K 40 26 16 390	K 40 40 16 390	PORT SIDE BOTTOM	1	1
9	K 40 26 18 390	K 40 40 18 390	PORT SIDE BACK	1	1
10	K 40 26 22 390	K 40 40 22 390	PORT FORWARD BOTTOM	1	1
11	K 40 26 24 390	K 40 40 24 390	PORT FORWARD BACK	1	1
12	K 40 26 25 390	K 40 40 25 390	QUARTERBERTH STARBOARD BACK	1	1
13	K 40 26 27 390	K 40 40 27 390	QUARTERBERTH STARBOARD BOTTOM	1	1
14	K 40 26 29 390	K 40 40 29 390	QUARTERBERTH PORT BOTTOM	1	1
15	K 40 26 31 390	K 40 40 31 390	QUARTERBERTH PORT FORWARD BACK	1	1
16	K 40 26 33 390	K 40 40 33 390	QUARTERBERTH PORT AFT BACK	1	1
	K 40 26 00 390		4" FABRIC, SET	1	
		K 40 40 00 390	PILLOW TYPE SET		1
	K 40 50 00 677		MALE BUTTON	12	
	K 40 51 00 390		CUSHION PRESS SNAP, BLACK PLASTIC	8	
	K 40 51 00F		FASTENER KIT: (1) #6x3/8" PHIL. PHSMS, S.S.	8	

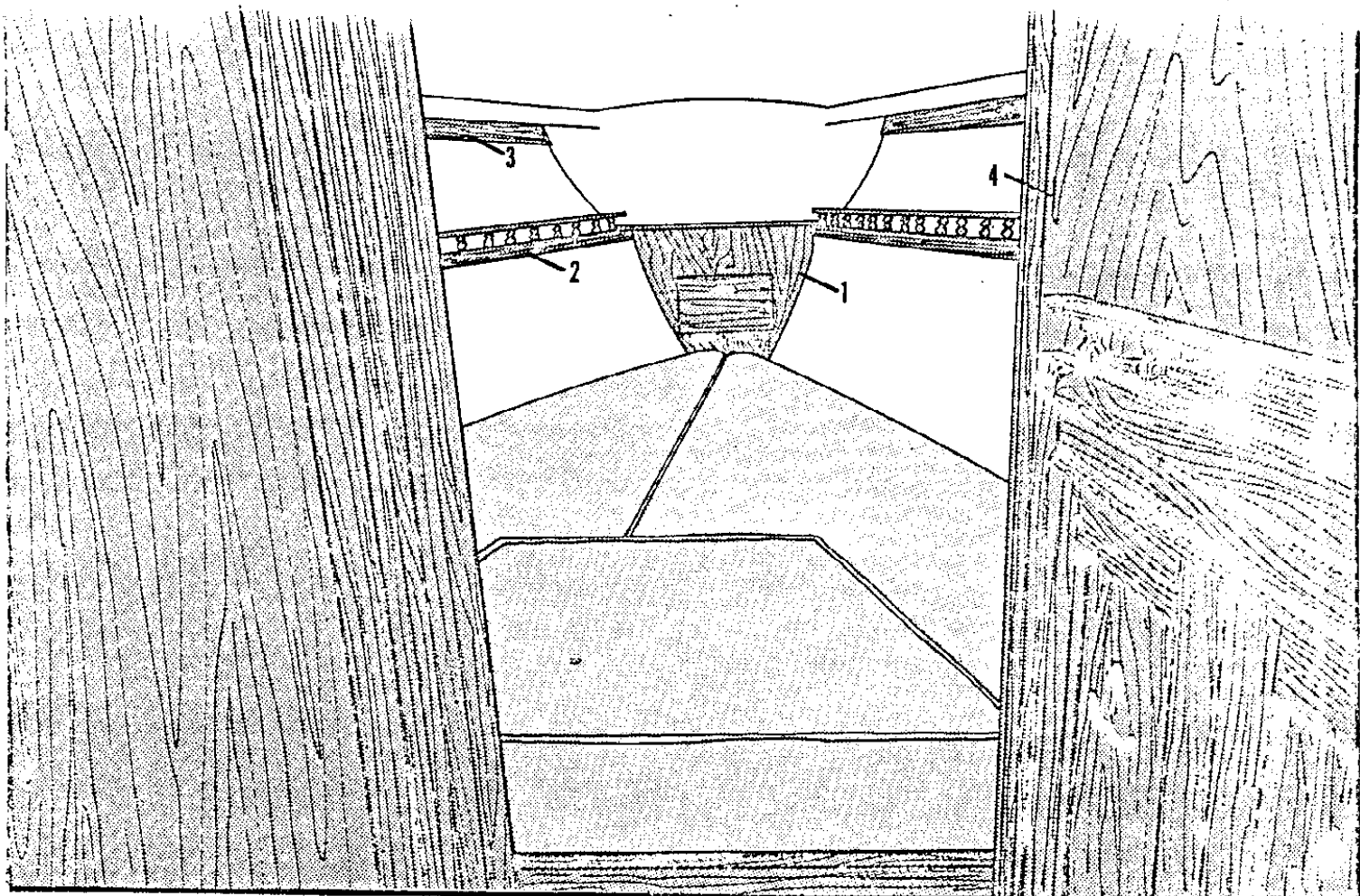

REF.	PART NUMBER	DESCRIPTION	STD./OPT.
1	K 43 01 43 285	FOREPEAK BULKHEAD W/DOOR, TEAK	1
	K 43 01 43F	FASTENER KIT: (2) #10x1" SLOT. OHSMS, S.S. (2) #10 FINISH WASHER, S.S.	1
2	K 46 03 08 285	FORWARD CABIN PINRAIL, 6'-9 1/2" TEAK	2
	K 46 03 08F	FASTENER KIT: (5) #10x1" SLOT. OHSMS, S.S. (5) #10 FINISH WASHER, S.S.	2
3	K 46 01 01 285	HULL DECK INTERFACE, 6-2", TEAK	2
	K 46 01 01F	FASTENER KIT: (3) #10x1" SLOT. OHSMS, S.S. (3) #10 FINISH WASHER, S.S.	2
	K 42 07 11 285	V-BERTH STORAGE DOOR AND FRAME, TEAK	1
	K 42 07 11F	FASTENER KIT: (4) #10x1 1/4" SLOT. OHSMS, S.S. (4) #10 FINISH WASHER, S.S.	1
4	K 43 01 25 285	STARBOARD FORWARD CABIN BULKHEAD, TEAK	1
	K 43 01 26 285	2"x3"x5" ANGLE, BROWN ANODIZED ALUMINUM	1
	K 43 01 25-26F	FASTENER KIT: (2) 3/8"-16x1 3/4" SLOT. RHSMS, S.S. (2) 3/8" FLAT WASHER, S.S. (2) 3/8" LOCK WASHER, S.S. (2) 3/8"-16 HEX NUT, S.S. (9) 5/16"-18x1 1/4" SLOT. RHMS, S.S. (15) 5/16" FLAT WASHER, S.S. (9) 5/16" LOCK WASHER, S.S. (9) 5/16"-18 HEX NUT, S.S. (15) #10x1 1/4" SLOT. OHSMS, S.S. (15) #10 FINISH WASHER, S.S.	1

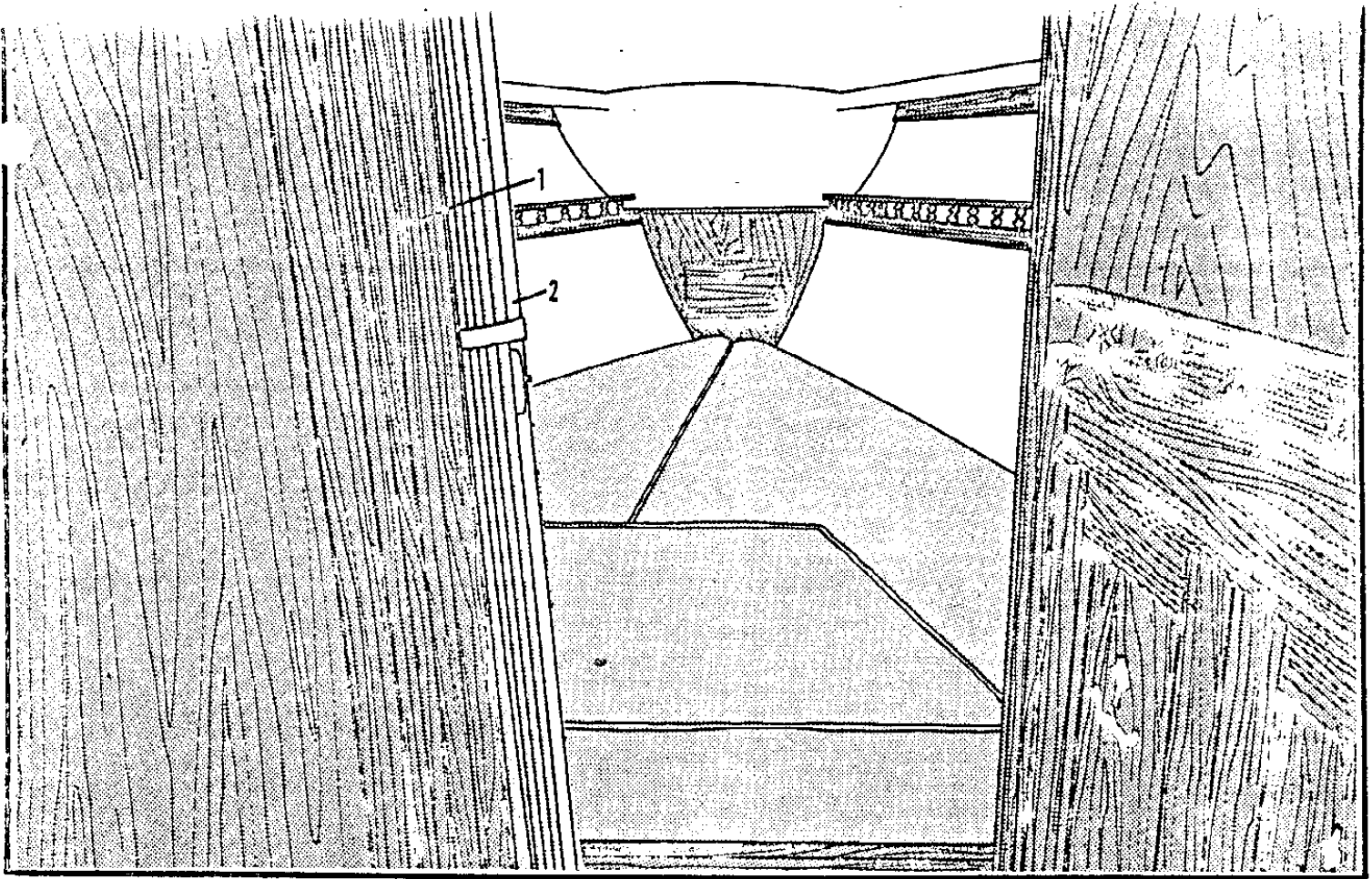

QTY.	PART NUMBER	DESCRIPTION	STD./OPT
1	K 43 01 33 285	PORT FORWARD CABIN BULKHEAD, TEAK	1
	K 43 01 26 255	2"x3"x5" ANGLE, BROWN ANODIZED ALUMINUM	1
	K 43 01 26-33F	FASTENER KIT: (2) 3/8"-16x1 3/4" SLOT. OHSMS, S.S.	1
		(2) 3/8" FLAT WASHER, S.S.	
		(2) 3/8" LOCK WASHER, S.S.	
		(2) 3/8"-16 HEX NUT, S.S.	
		(7) 5/16"-18x1 1/4" SLOT. RHMS, S.S.	
		(11) 5/16" FLAT WASHER, S.S.	
		(7) 5/16" LOCK WASHER, S.S.	
		(7) 5/16"-18 HEX NUT, S.S.	
2	K 42 05 01 170	FORWARD CABIN SLIDING DOOR W/TIE BACK, VINYL	1
	K 42 05 01F	FASTENER KIT: (4) #10x1" SLOT. OHSMS, S.S.	1
		(4) #10 FINISH WASHER, S.S.	1
	K 42 05 03 170	20" DOOR TRACK, BROWN ANODIZED ALUMINUM	1
	K 42 05 03F	FASTENER KIT: (3) #6x1 1/2" SLOT. PHSMS, S.S.	1
	K 42 05 05 285	DOOR TRACK BACKING, TEAK	1
	K 42 05 05F	FASTENER KIT: (1) #6x2" SLOT. PHSMS, S.S.	1
		(1) #6x1 1/2" SLOT. PHSMS, S.S.	1
	K 42 05 09 677	MALE BUTTON, ON BULKHEAD	1
	K 42 05 00 100	FORWARD CABIN SLIDING DOOR, COMPLETE ASSEMBLY	1

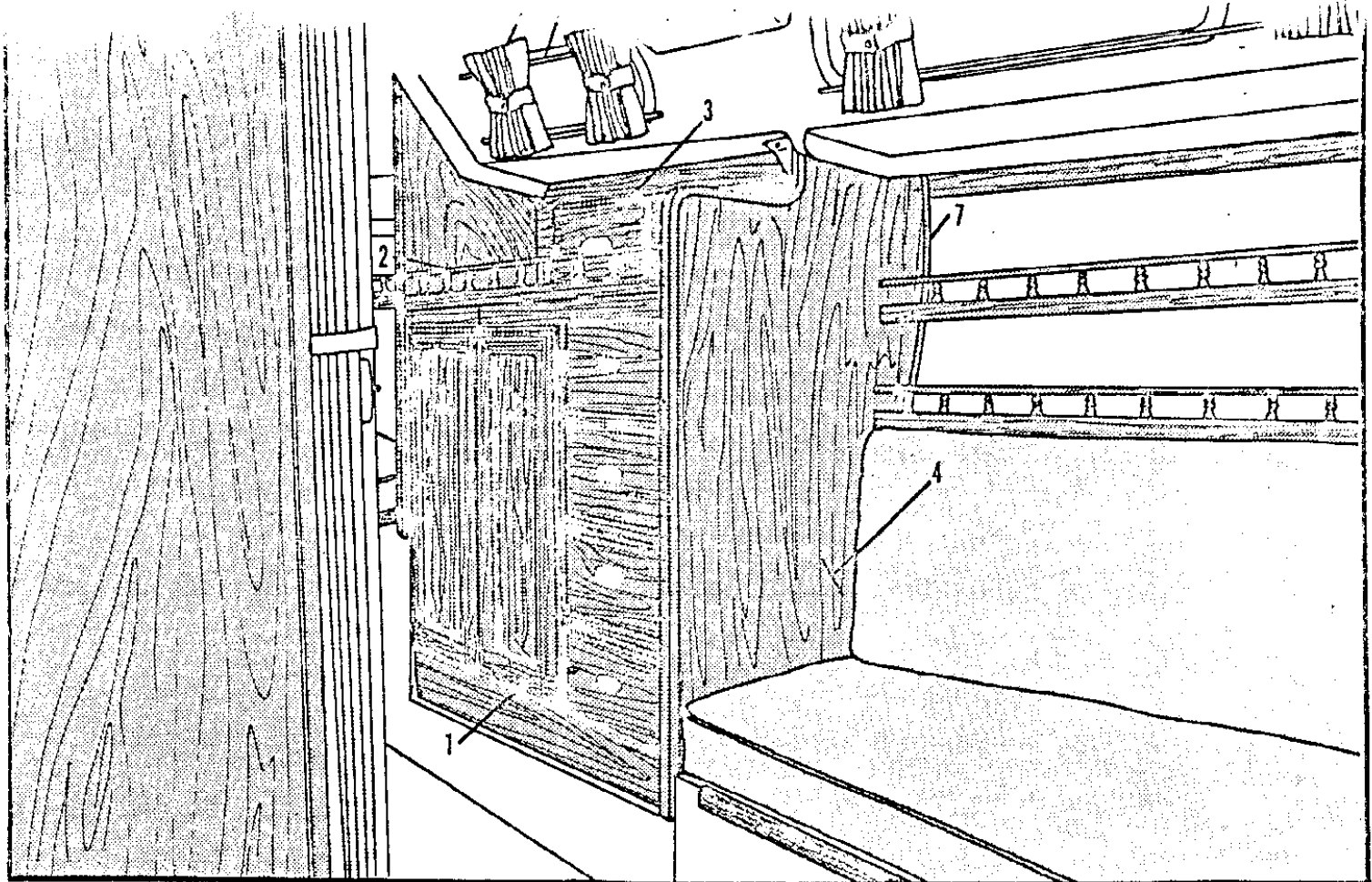

REF.	PART NUMBER	DESCRIPTION	STD./OPT.
1	K-43 03 24 285	HANGING LOCKER, W/2 DOORS AND 4 DRAWERS, TEAK	1
	K 43 03 24F	FASTENER KIT: (6) #10x1 1/2" SLOT. OHSMS, S.S. (6) #10 FINISH WASHER, S.S.	1
2	K 43 03 07 285	HANGING LOCKER TOP W/PINRAIL, TEAK	1
	K 43 03 07F	FASTENER KIT: (2) #10x1 1/2" SLOT. OHSMS, S.S. (2) #10 FINISH WASHER, S.S.	1
3	K 43 03 26 285	HANGING LOCKER STORAGE, W/2 DOORS, TEAK	1
	K 43 03 26F	FASTENER KIT: (5) #10x1 1/2" SLOT. OHSMS, S.S. (5) #10 FINISH WASHER, S.S.	1
	K 43 03 13 285	HANGING LOCKER DOWEL, 1 1/4"x20 1/2"	1
	K 43 03 15 285	HANGING LOCKER DOWEL SOCKET, WHITE PLASTIC	2
	K 43 03 15F	FASTENER KIT: (1) #10x1/2" SLOT. OHSMS, S.S.	2
	K 43 03 00 100	HANGING LOCKER ASSEMBLY, COMPLETE	1
4	K 43 01 01 285	STARBOARD MAIN CABIN BULKHEAD, TEAK	1
	K 43 01 01F	FASTENER KIT: (3) #10x1 1/4" SLOT. OHSMS, S.S. (3) #10 FINISH WASHER, S.S. (5) 3/8"-16x2" SLOT. RHMS, S.S. (10) 3/8" FLAT WASHER, S.S. (5) 3/8" LOCK WASHER, S.S. (5) 3/8"-16 HEX NUT, S.S.	1
5	K 42 01 02 390	FORWARD CURTAIN W/SLIDES.	4
6	K 42 01 06 390	CURTAIN TRACK W/END STOPS, 18"	4
	K 42 01 07 390	CLIP, S.S.	8
7	K 43 01 75 100	BATTING, BROWN VINYL SHEATH, SPECIFY LENGTH	1

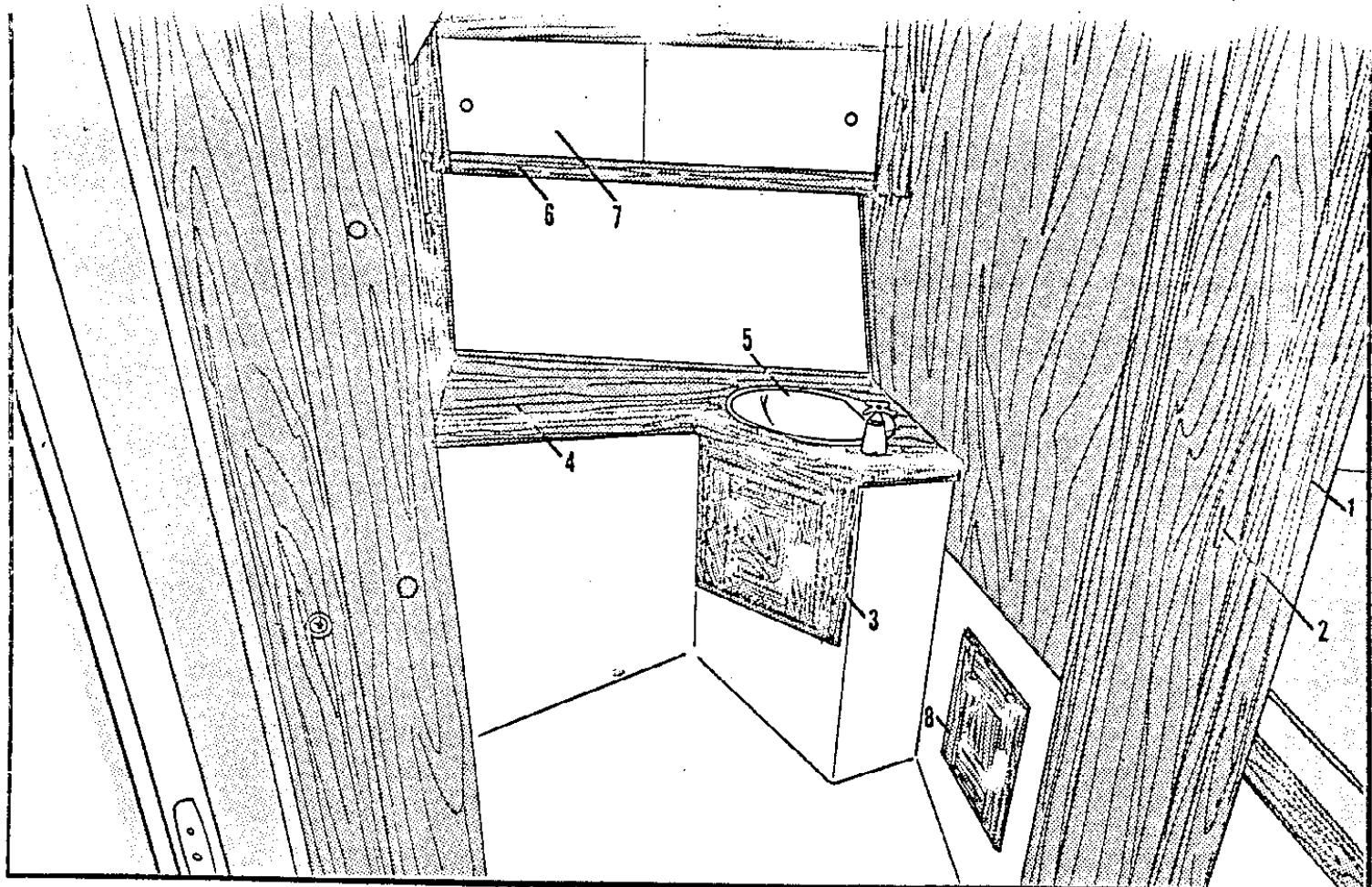

	PART NUMBER	DESCRIPTION	STD./OPT.
1	K 44-02 03 285	PORT FORWARD BULKHEAD TRIM, TEAK	1
	K 44 02 03F	FASTENER KIT: (2) #10x2" SLOT. OHSMS, S.S. (1) #10x1 1/4" SLOT. OHSMS, S.S. (1) #10 FINISH WASHER, S.S.	1
2	K 44 02 05 285	HEAD COMPARTMENT PANEL W/TRIM, TEAK	1
	K 44 02 05F	FASTENER KIT: (3) #10x1 1/4" SLOT. OHSMS, S.S. (3) #10 FINISH WASHER, S.S.	1
	K 44 02 09 285	HEAD COMPARTMENT DOOR W/PIANO HINGE, TEAK	1
	K 44 02 09F	FASTENER KIT: (33) #5x5/8" PHIL. PHSMS, S.S.	1
	K 44 02 11 400	HASP AND EYE, CHROME PLATED	2
	K 44 02 11F	FASTENER KIT: (4) #6x5/8" PHIL. PHSMS, S.S.	2
	K 44 02 00 100	HEAD COMPARTMENT DOOR, COMPLETE ASSEMBLY	1
3	K 44 00 01 285	COUNTER ACCESS DOOR AND FRAME, TEAK	1
	K 44 00 01F	FASTENER KIT: (4) #10x1 1/4" SLOT. OHSMS, S.S. (4) #10 FINISH WASHER, S.S.	1
4	K 44 00 05 285	HEAD COUNTER TOP, TEAK	1
	K 44 00 05F	FASTENER KIT: (4) #10x1 1/4" SLOT. OHSMS, S.S. (4) #10 FINISH WASHER, S.S.	1
5	K 44 00 09 734	WASH BASIN, S.S.	1
	K 44 00 09F	FASTENER KIT: (4) JIFFY CLAMP, S.S.	1
	K 44 00 11 734	WASH BASIN STOPPER, S.S.	1
6	K 46 05 08 285	HEAD COMPARTMENT STORAGE SHELF, TEAK	1
	K 46 05 08F	FASTENER KIT: (4) #10x1 1/2" SLOT. OHSMS, S.S. (4) #10 FINISH WASHER, S.S.	1
	K 46 05 09 285	SLIDING GLASS	2
8	K 42 07 19 285	MARINE HEAD THRU HULL ACCESS DOOR AND FRAME, TEAK	1
	K 42 07 19F	FASTENER KIT: (4) #10x1 1/4" SLOT. OHSMS, S.S. (4) #10 FINISH WASHER, S.S.	1

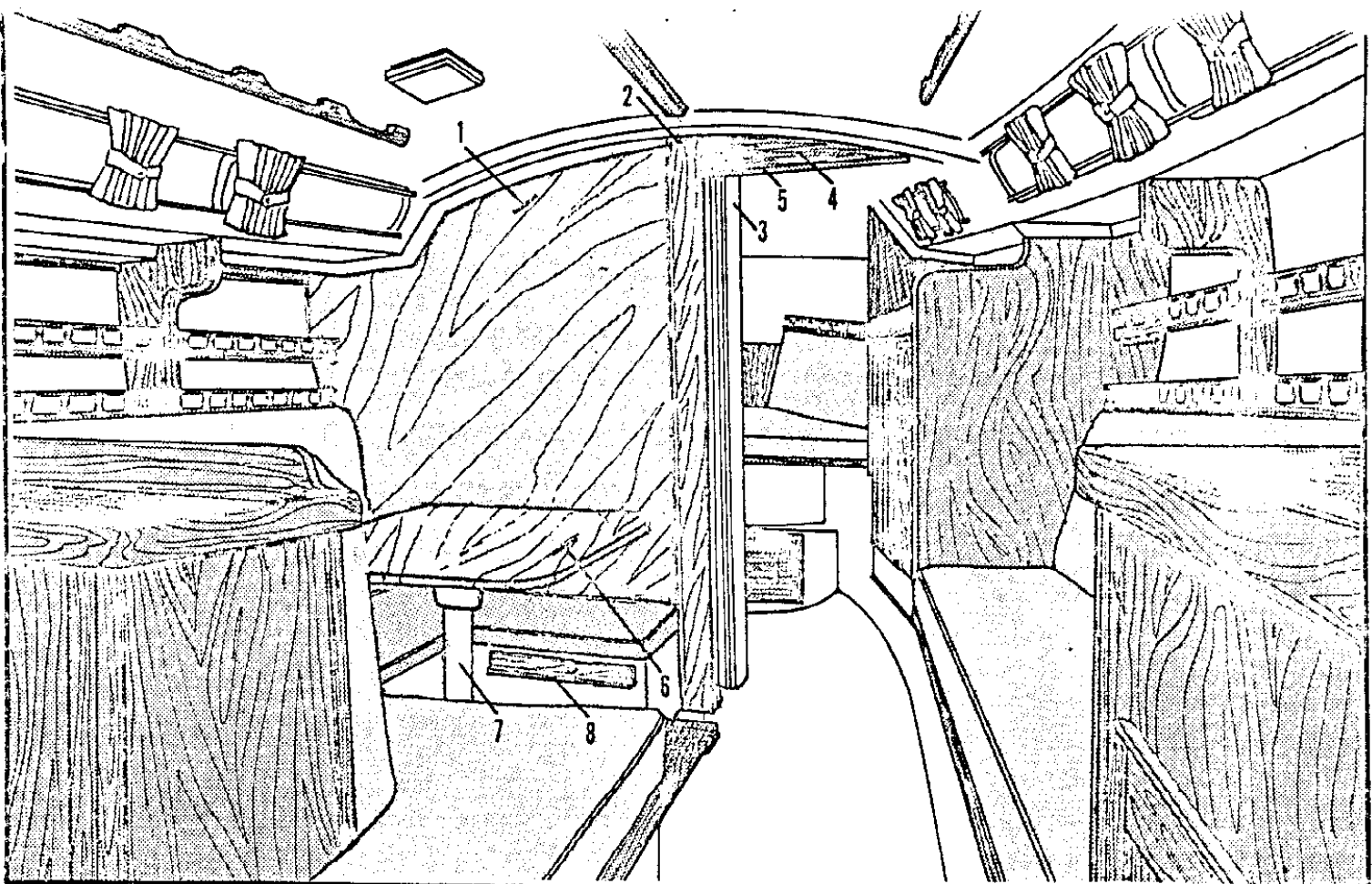

REF.	PART NUMBER	DESCRIPTION	STD./OPT.
1	K 43 01 15 285	PORT MAIN CABIN BULKHEAD, TEAK	1
	K 43 01 15F	FASTENER KIT: (14) #10x1 1/4" SLOT. OHSMS, S.S. (14) #10 FINISH WASHER, S.S. (4) 3/8"-16x1 1/2" SLOT. RHMS, S.S. (8) 3/8" FLAT, (4) 3/8" LOCK WASHER, S.S. (4) 3/8"-16 HEX NUT, S.S.	1
2	K 43 02 01 285	COMPRESSION POST, TEAK	1
	K 43 02 01F	FASTENER KIT: (6) #12x3" SLOT. RHWS, S.S.	1
3	K 42 03 01 285	MAIN CABIN SLIDING DOOR W/TIE BACK, VINYL	1
	K 42 03 01F	FASTENER KIT: (4) #10x1" SLOT. OHSMS, S.S. (4) #10 FINISH WASHER, S.S.	1
4	K 42 03 03 170	24" DOOR TRACK, BROWN ANODIZED ALUMINUM	1
	K 42 03 03F	FASTENER KIT: (4) #6x1 1/2" SLOT. PHSMS, S.S. (4) #6 FINISH WASHER, S.S.	1
5	K 42 03 05 285	DOOR TRACK FRAME	1
	K 42 03 05F	FASTENER KIT: (1) #6x2" SLOT. PHSMS, S.S. (1) #6x1 1/2" SLOT. PHSMS, S.S.	1
	K 42 03 07 677	MALE BUTTON, ON BULKHEAD	1
	K 42 03 00 170	MAIN CABIN SLIDING DOOR, COMPLETE ASSEMBLY	1
6	K 44 04 01 450	DINETTE TABLE TOP	1
7	K 44 04 09 250	DINETTE TABLE PEDESTAL, ALUMINUM	1
	K 44 04 09F	FASTENER KIT: (8) #10x3/4" SLOT. PHSMS, S.S. (6) #16x1 1/2" SLOT. FHWS, S.S.	1
8	K 44 04 15 285	DINETTE TABLE SUPPORT, 2'-6", TEAK	2
	K 44 04 15F	FASTENER KIT: (4) 1/4"-20x2" SLOT. FHMS, S.S. (4) 1/4" FLAT, LOCK WASHER, S.S. (4) 1/4"-20 HEX NUT, S.S.	2
	K 44 04 00 100	DINETTE INTERIOR TABLE, COMPLETE ASSEMBLY	1